

Werkstoff/Matière/Material
 .2 = Bronze/bronze
 .6 = Messing/laiton/brass
 .7 = Neusilber/mailechort/german silver

■ = Oberflächen/Surface/Surface-plating
 Seite/page/page 5.011

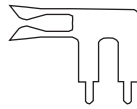
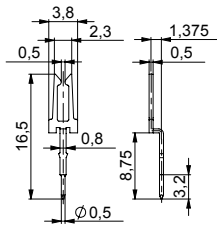
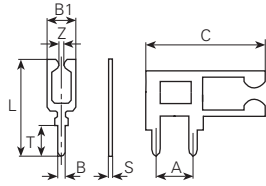

Artikelnummer
Numéro d'article
Part-No.

Bohrung/Trou/Hole

	1342a.2■	1341g.2■	1335.2■	1335l.2■	1341z.7■
Ø	0.5	0.8	0.8	0.8	1
T	3.2	3	4.2	4.2	1.8
L	16.5	13	12.8	12.8	16.8
B1		4.4	3.8	3.8	3.6
Z		1	0.45	0.6	0.5
A		5			2
C		17			
B		0.6	0.8	0.8	0.8
S	0.5	0.8	0.5	0.5	0.8
Werkzeuge Outils Toolings		26	12	12	6

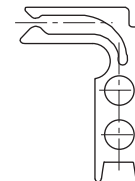
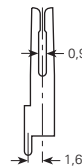
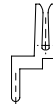
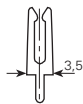

Artikelnummer
Numéro d'article
Part-No.

Bohrung/Trou/Hole

	1338.6■	1341.6■	1341d.2■	1347.6■	1341v.2■
Ø	1	1	1.1	1.1	1.2
T	3.5	4.3	2.5	4.2	3.2
L	12.6	12.9	19.5	17.8	29.6
B1	3	2.6	2.8	4.6	5.6
Z	1	0.7	0.55	1.7	1.4
A					7
C					20.7
B	1	1.1	1	1	1.2
S	0.7	0.6	0.8	0.7	0.8
Werkzeuge Outils Toolings	65			22	24

Werkstoff/Matière/Material
 .2 = Bronze/bronze
 .6 = Messing/laiton/brass
 .7 = Neusilber/mailechort/german silver

■ = Oberflächen/Surface/Surface-plating
 Seite/page/page 5.011

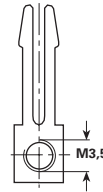
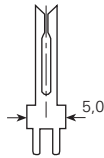
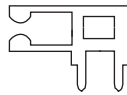
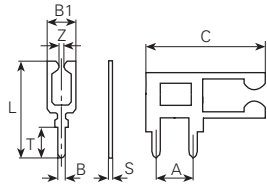

Artikelnummer
 Numéro d'article
 Part-No.

Bohrung/Trou/Hole

Werkzeuge
 Outils
 Toolings

1341f.2

∅ 1.2
 T 3.3
 L 11.3
 B1 5.5
 Z 0.85
 A 5
 C 15.9
 B 1
 S 0.8

26

1341r.2

∅ 1.2
 T 3.5
 L 20
 B1 3
 Z 0.5
 A 2.5
 C
 B 1
 S 0.8

45

01341r.2

∅ 1.2
 T 3.5
 L 20
 B1 3
 Z 0.5
 A 2.5
 C
 B 1
 S 0.8

1041r

1338a.6

∅ 1.4
 T 5.8
 L 20.7
 B1 5.2
 Z 2
 A
 C
 B 1.4
 S 0.8

41

1341h.6

∅
 T 7.5
 L 23.5
 B1 4.8
 Z 1.4
 A
 C
 B 6.5
 S 1.5

Tülle
Douille
Housing

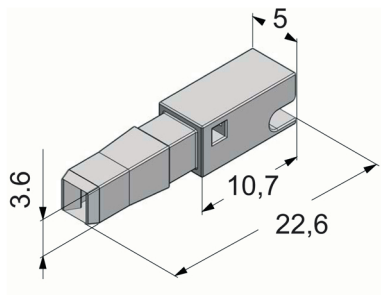

1004z

Kontaktfeder 2,0x0,8 mm
Ressort de contact
Contact springs for
0,5 mm² / AWG 22

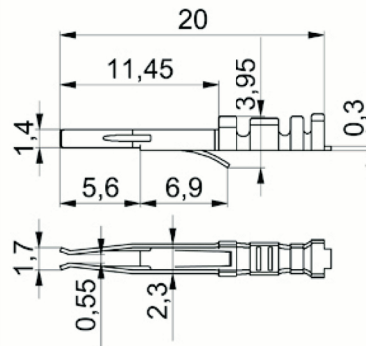

1004y